

Hardware Quick Reference LANCOM R&S®UF-60

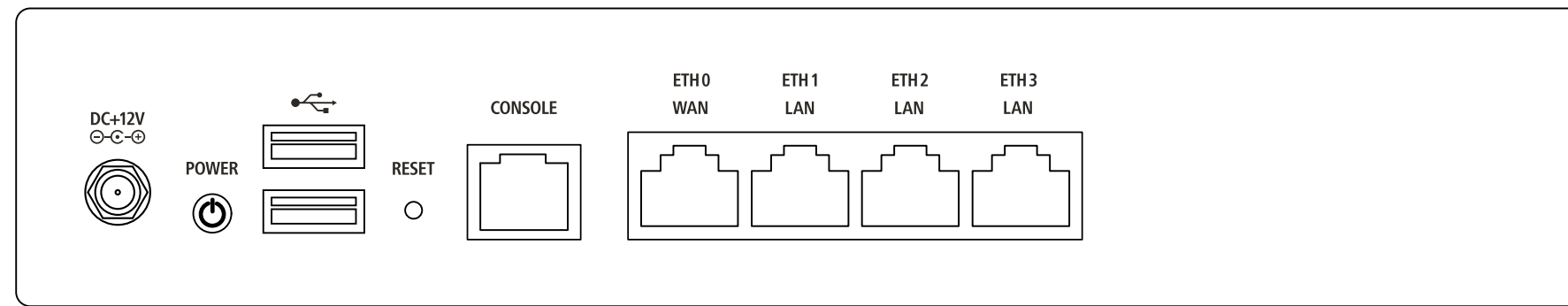

- ①
- ②
- ③
- ④
- ⑤
- ⑥
- ⑦

- ① **Connection socket for power supply**
After connecting the power supply cable to the device, turn the screwcap clockwise to prevent the jack from accidental unplugging. Use only the supplied power adapter.
- ② **Power button**
Press the power button to start up the device. To power off the device, press the power button for 5 seconds.
- ③ **USB 3.0 interfaces**
Interfaces for device software re-installation
- ④ **Reset button**
Short press - device restart
- ⑤ **Serial configuration interface RJ45 (Console)**
Maintenance interface for expert configuration

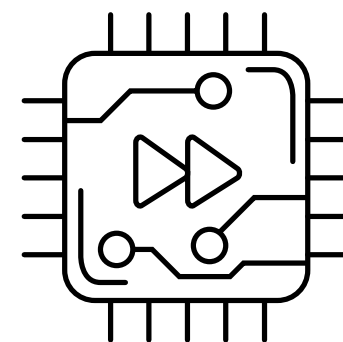
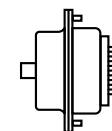
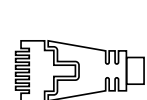
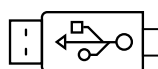

- ⑥ **TP Ethernet interface ETH0 (WAN)**
Connect the ETH0 TP Ethernet interface to other network components. This interface is recommended for Internet access. Please refer to the corresponding product supplement for instructions on initial commissioning.
- ⑦ **TP Ethernet interfaces ETH1 - ETH3 (LAN)**
Connect the ETH1 - ETH3 TP Ethernet interfaces with the enclosed Ethernet cable to other networking components. Please refer to the corresponding product supplement for instructions on initial commissioning.

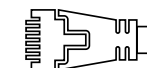
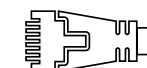

Before initial startup, please make sure to take notice of the information regarding the intended use under www.lancom-systems.com/safety!

Operate the device only with a professionally installed power supply at a nearby power socket that is freely accessible at all times.



Please observe the following when setting up the device
 → The mains plug of the device must be freely accessible.
 → Do not rest any objects on top of the device and do not stack multiple devices.
 → Keep the device's ventilation slots clear of obstruction.
 → Mount the device into a 19" unit in a server rack using the separately available rack mount.

Mounting & connecting

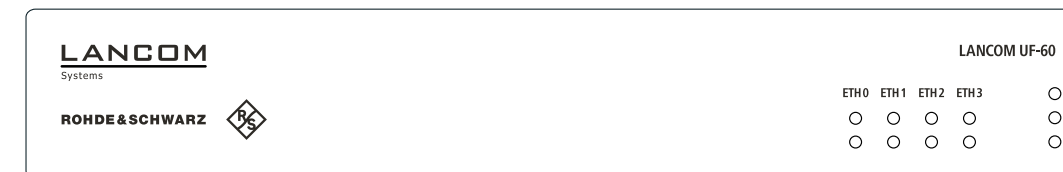

① LEDs ETH0 - ETH3 - TP Ethernet

Upper LEDs - link activity

Off	No link detected
Green, permanently	Link detected, no port activity
Green, blinking	Link detected, port activity

Lower LEDs - link speed

Off	Link speed 10 Mbps
Orange, permanently	Link speed 100 Mbps
Green, permanently	Link speed 1000 Mbps

② LEDs Power / HDD

Power off	Device switched off
Power green	Device operational
HDD off	No HDD read-/write access
HDD blue, flickering	HDD read-/write access

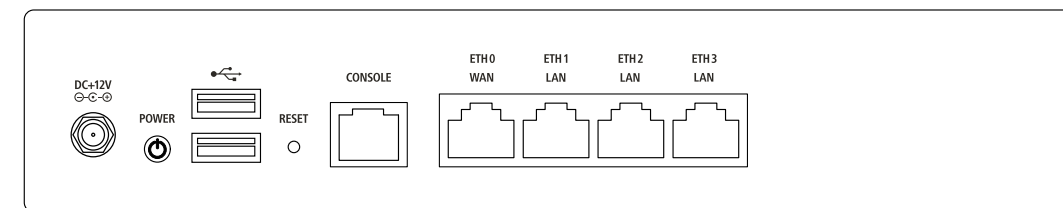

③ LED Power switch

Off	No power supply connected
Red, permanently	Device switched off, power supply connected
Blue, permanently	Device switched on

④ LEDs ETH0 - ETH3 - TP Ethernet

Both off	Device switched off or no network device connected
Left green, flickering Right green, permanently	Data transfer 1000 Mbps
Left green, flickering Right orange, permanently	Data transfer 100 Mbps
Left green, flickering Right off	Data transfer 10 Mbps

Hardware

Power supply	12 V DC, external power supply
Power consumption	Max. 40 W
Environment	Temperature range 0-40 °C; humidity 10-85 %, non-condensing
Housing	Robust metal housing, network connectors on the front
Dimensions (mm)	232 x 44 x 115 (W x H x D)

Interfaces

ETH	4x 10 / 100 / 1000 Mbps Gigabit Ethernet ports
USB	2x USB 3.0 ports
Console	RJ45 configuration interface

Package content

Accessories	1 Ethernet cable; 1 power supply unit with IEC power cable; 1 set adhesive rubber pads
-------------	----------------------------------------------------------------------------------------

Hereby, LANCOM Systems GmbH | Adenauerstrasse 20/B2 | D-52146 Wuerselen, declares that this device is in compliance with Directives 2014/30/EU, 2014/35/EU, 2011/65/EU, and Regulation (EC) No. 1907/2006. The full text of the EU Declaration of Conformity is available at the following Internet address: www.lancom-systems.com/doc